



YHS

Yuhai Technology & Manufacturing Supplies Pvt Ltd

Plot No.183/184,ECOTECH-1 Extension Kasna, Greater Noida-201310 (UP) INDIA

Email: yuhaitech@gmail.com esdyuhai@gmail.com

Web :WWW.Yuhai-tech. com

Contact:+91-9711074227/9650837069.

宇海技术与生产供应私人有限公司

Yu Hai Technology & Manufacturing Supplies Pvt Ltd.

Main scope: laser sheet metal processing, belt assembly line, line rod lean pipe products, all kinds of storage shelves, various series of turnover car series, anti-static consumables, etc

宇海技术与生产供应私人有限公司

YU HAI TECHNOLOGY & MANUFACTURING SUPPLIES PVT LTD

II 企业简介 YHS

宇海技术与生产供应私人有限公司成立于2017年3月，拥有全套机械加工设备，以及专业的技术开发队伍。专业从事研究、开发、制造各种智能输送机系统，有皮带输送机，滚筒输送机，爬坡输送机，转弯机，链板线，升降机，可伸缩装卸货输送机，铁氟龙耐高温输送机，倍速链组装机、移栽机自动插件线，自动组装机，工作台输送机，全系列装配生产线、老化生产线、电源回馈负载、电子输送设备及无尘车间进化通风设备等。

公司坚持以“信誉第一，用户至上”为经营宗旨，以“诚实为人，严谨处事”为经营理念，树立“管理从严、技术过硬、稳步发展”为经营管理，曾服务的客户包括vivo, oppo, 传音, TCL, 华星光电, 联创电子, 合力泰, TATA, Samkang等在印的中资、印资、韩资客户。宇海正以不懈的努力，秉着专业、敬业、创新的企业精神，架起科技转化生产力的桥梁！

We have 6 years experience in manufacturing all kinds of Belt Conveyor systems and assembly line with good quality and competitive price. Our main products are auto pallet assembly line, Belt conveyor systems, roller conveyor systems, unloading belt conveyor systems, 90-degree, 180-degree 360-degree Curved turning conveyor systems, Inclined Climbing belt systems, Chain line Conveyor, Telescopic Conveyor, etc, which can be applied in all kinds of home appliances, goods transporting and other fields.

All of our products are customized, Welcome your own dimension or we can design it according to your on-site requirements. Conveyor system works to save time, save human, maximum limit reduce the cost of production. We also provide video technical support, online support and spare parts for installing! Welcome to contact with us for detail discussion to meet your wants!



YUHAI Technology & Manufacturing Supplies Pt Ltd was established on March.2017 all promoters of YUHAI have an extensive experience of more than 15 years in the field of "static Electricity & ESD Control" . Having served the industry with tull ommitment, we have developed ourselves as manufacturers and service providers o Production Lines. We are specialized in designing & Manufacturing of various types of working Tables, Assembly Lines & Conveyor Lines etc. We provide various solutions for Lean Production, Material Handling, Material Storage ,Logistics and Distribution etc.

we can design & Manufacture customized systems that are in accordance to the customers' requirements. Our products are widely used in Electronics, Automo-bile, Food-Processing, Pharmaceutical, Logistics & Courier ,and Toys and have very good reputation among our customers.

We follow our policy of "Guided by Customers Requirement with the intent of Refinement & Innovation" We focus on our products to help customers building intelligent factories and improve their core competitiveness.

宇海技术与生产供应私人有限公司成立于2017年3月，中国公司在“静电与静电控制”领域拥有超过15年的丰富经验。在为行业提供全面服务的基础上，我们发展成为生产线的制造商和服务商，专业设计和制造各种类型的工作台、装配线和传送线等，我们为精益生产、物料搬运、物料仓储、物流和配送等提供各种解决方案。

我们的产品广泛应用于电子、汽车、食品加工、制药、物流和快递、玩具等行业，在客户中享有很高的声誉。

我们遵循“以客户需求为导向，精益求精，不断创新”的方针，专注于产品，帮助客户建立智能工厂，提高核心竞争力。

VIETNAM FACTORY COMPANY SITUATION 越南工厂公司情况



宇海技术与生产供应私人有限公司

YU HAI TECHNOLOGY & MANUFACTURING SUPPLIES,PVT LTD



1) # Plot No.183/184,ECOTECH-1 Extension Karna, Greater Noida-201310 (UP)INDIA
 2) Plot No. 117, S.V. Autonagar, Renigunta Road, Tirupati, Distt. Chittoor, Andhra Pradesh 517501
 Email: yuhaitech@gmail.com esdyuhai@gmail.com
 Web: WWW.Yuhai-tech.com
 Contact: +91-9711074227/9650837069

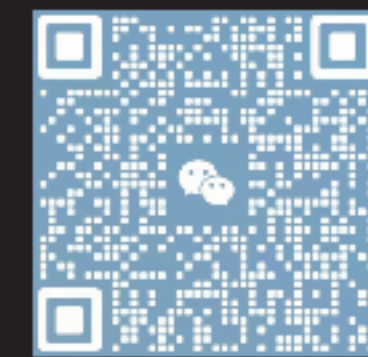

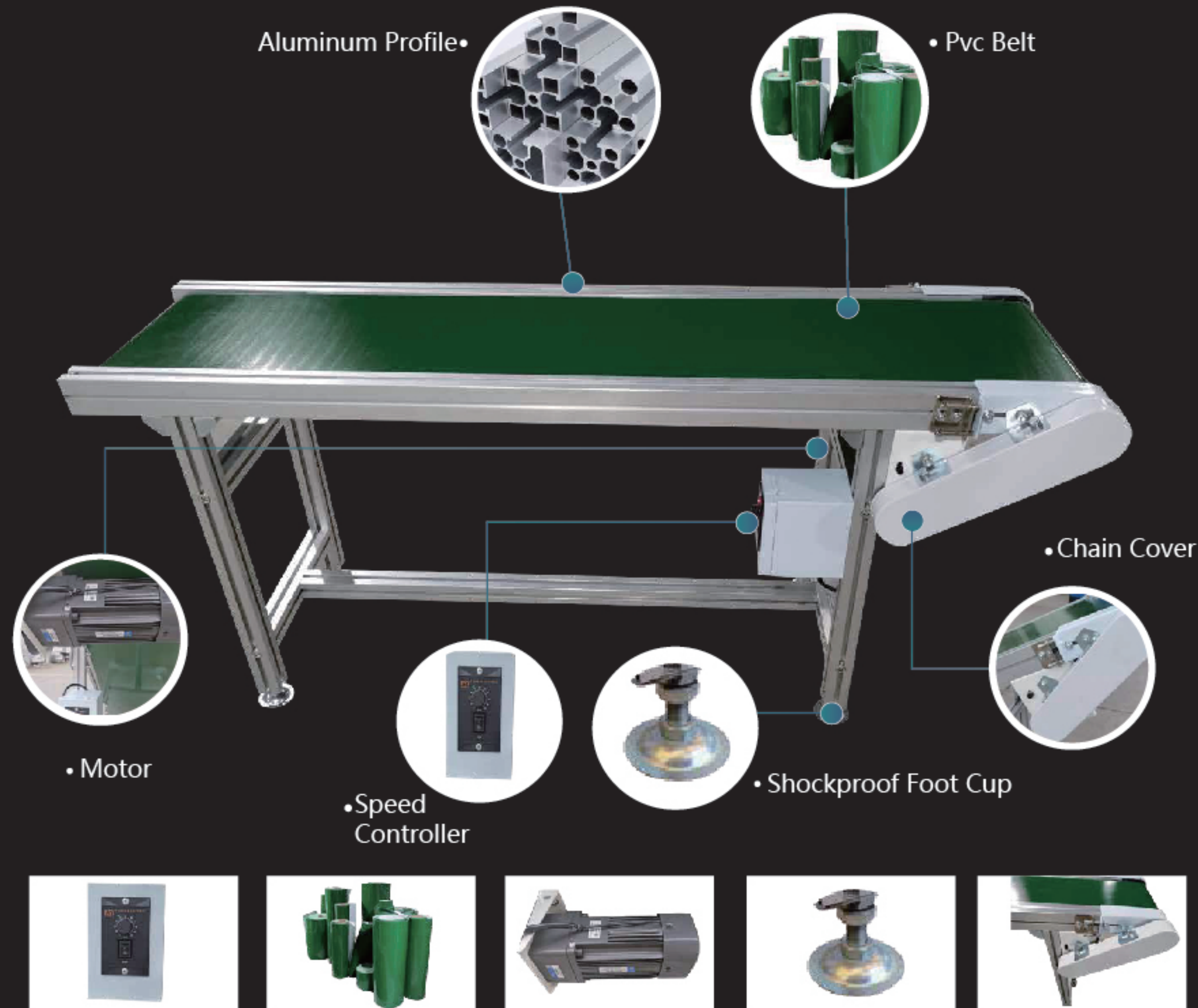

Brand: Yuhai	Name: Belt Conveyor Line
Model Number: Yuhai#001	Product Size: 800mm长* 300mm宽* 500mm高
Body Material: Aluminum Profile	Belt: Green Pvc
Purpose: Transmit/transport Goods	
Inverter Voltage: 110v; 220v; 380v; 415v; 50hz; 60hz	
Adjustable Speed: 1-25m/min(1-20/min Slow; 10-15m/min Normal Speed; 15-25m/min Fast)	
Maximum Load: 50-100kgs	Minimum Order Quantity: 1 Set
Motor: Brand Optional, 60w; 90w; 120w; 200w; 250w; 400w; 750w; 1000w; 1500w	
Delivery Time: 5 Days Volume Negotiable	Installation: Provide Installation Video; Online Guidance; Onsite Installation.



Flapper Belt Conveyor

Flapper Belt Conveyor

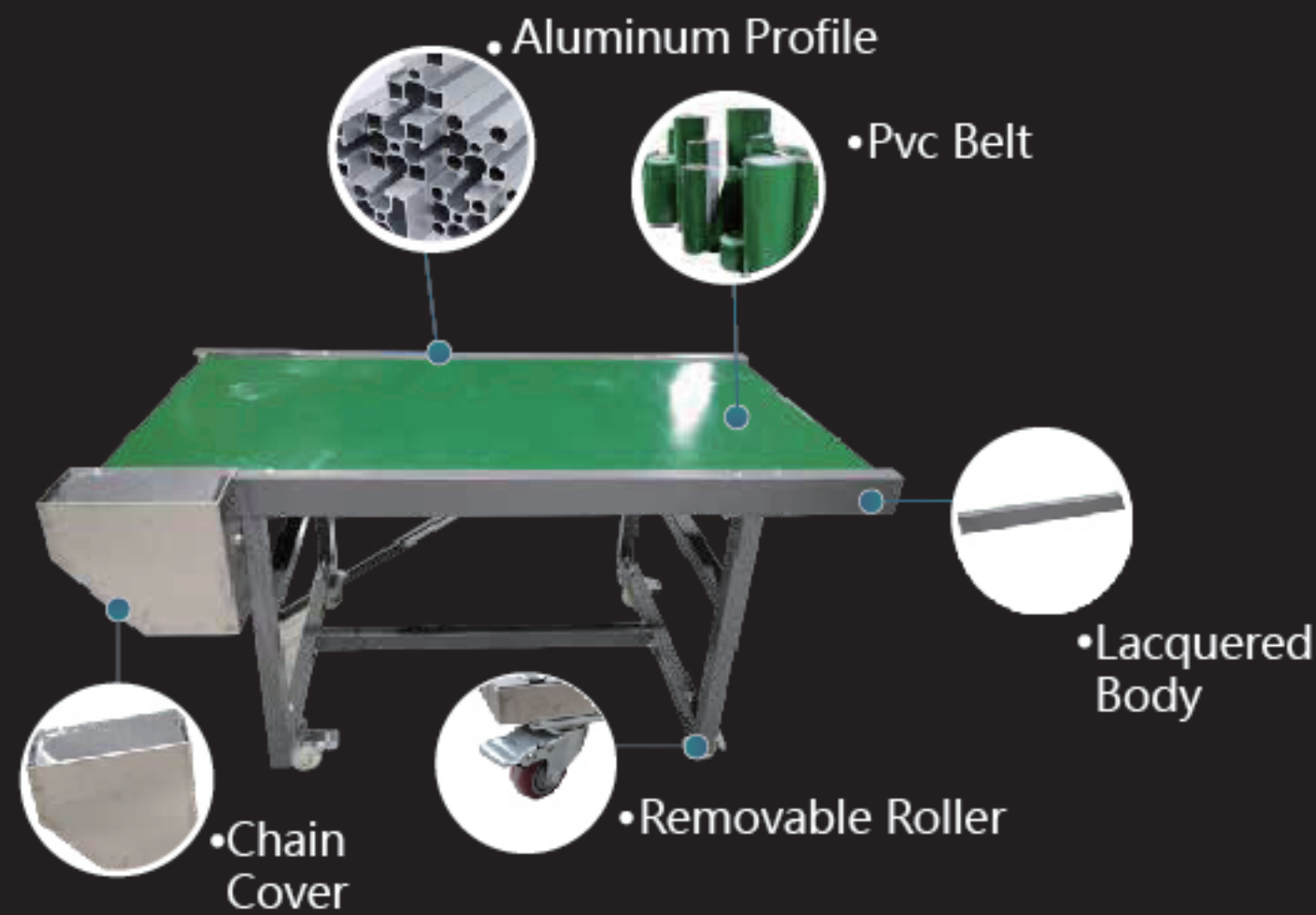

Brand: Yuhai **Name:** Belt Conveyor Line
Model Number: Yuhai#002 **Product Size:** 1000mm长* 300mm宽* 500mm高
Body Material: Steel Paint **Belt:** Green Pvc
Purpose: Transmit/transport Goods **Motor:** Brand Optional, 60w; 90w; 120w; 200w; 250w; 400w; 750w; 1000w; 1500w
Inverter Voltage: 110v; 220v; 380v; 415v; 50hz; 60hz
Adjustable Speed: 1-25m/min(1-20/min Slow; 10-15m/min Normal Speed; 15-25m/min Fast)
Maximum Load: 50kgs **Minimum Order Quantity:** 1 Set
Delivery Time: 5 Days Volume Negotiable **Installation:** Provide Installation Video; Online Guidance; Onsite Installation.



Brand: Yuhai **Name:** Belt Conveyor Line
Model Number: Yuhai#003 **Product Size:** 1200mm长*900mm宽*700mm高
Body Material: Aluminum Profile **Belt:** Green Pvc With Baffle 30mm High
Purpose: Transmit/transport Goods **Maximum Load:** 50kgs
Motor: Brand Optional, 60w; 90w; 120w; 200w; 250w; 400w; 750w; 1000w; 1500w
Inverter Voltage: 110v; 220v; 380v; 415v; 50hz; 60hz
Adjustable Speed: 1-25m/min(1-20/min Slow; 10-15m/min Normal Speed; 15-25m/min Fast)
Minimum Order Quantity: 1 Set **Delivery Time:** 5 Days Volume Negotiable
Installation: Provide Installation Video; Online Guidance; Onsite Installation.



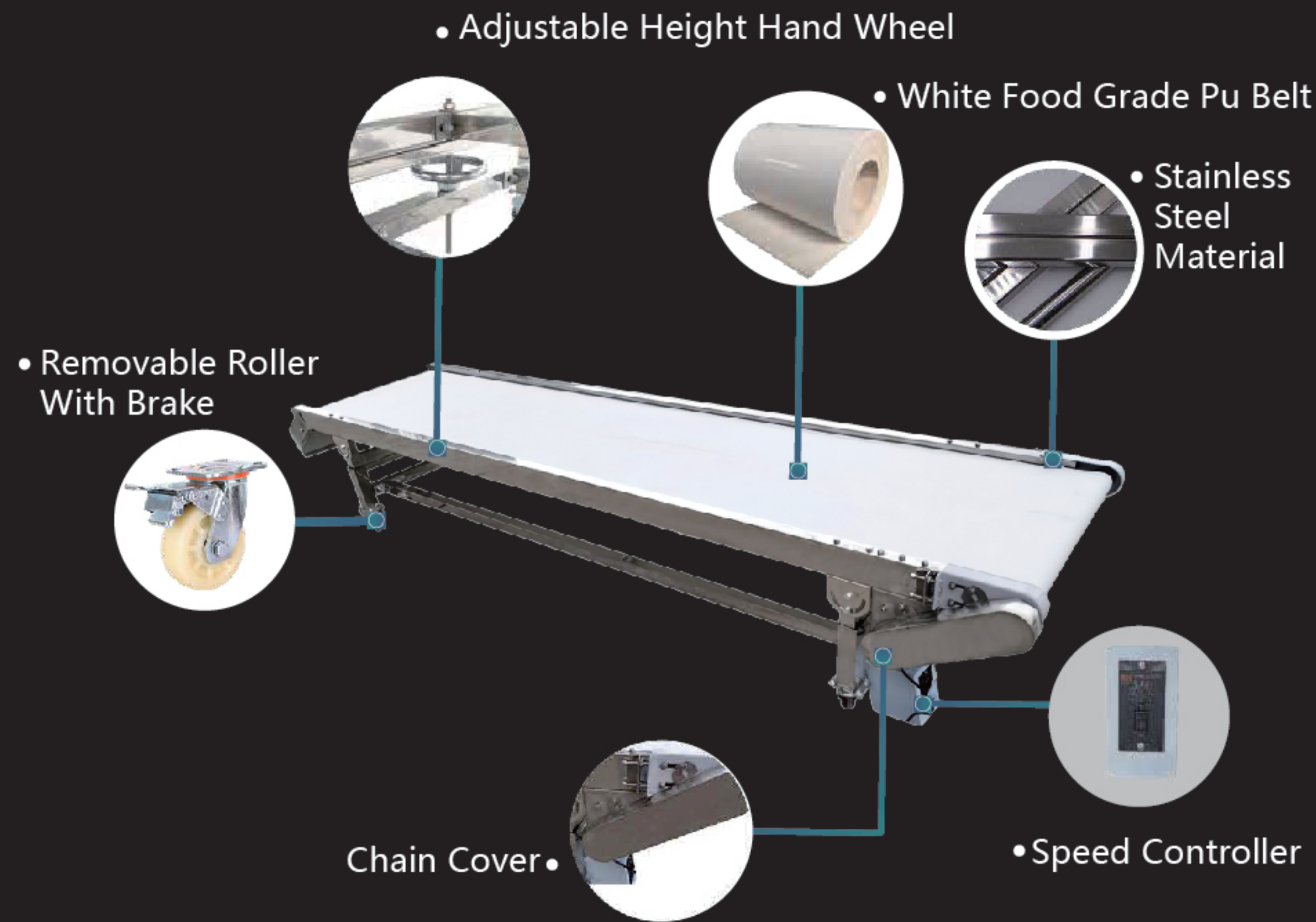

Brand: Yuhai	Name: Belt Conveyor Line
Model Number: Yuhai#005	Product Size: 3000mm长* 600mm宽* 350mm高
Body Material: 304 Stainless Steel	Belt: White Food Grade Pu Belt
Purpose: Conveying Goods	Maximum Load: 250kgs
Inverter Voltage: 110v; 220v; 380v; 415v; 50hz; 60hz	
Adjustable Speed: 1-25m/min(1-20/min Slow; 10-15m/min Normal Speed; 15-25m/min Fast)	
Minimum Order Quantity: 1 Set	Delivery Time: 5 Days Volume Negotiable
Motor: Brand Optional, 60w; 90w; 120w; 200w; 250w; 400w; 750w; 1000w; 1500w	
Adjustable Speed: 1-25m/min(1-20/min Slow; 10-15m/min Normal Speed; 15-25m/min Fast)	
Installation: Provide Installation Video; Online Guidance; Onsite Installation.	



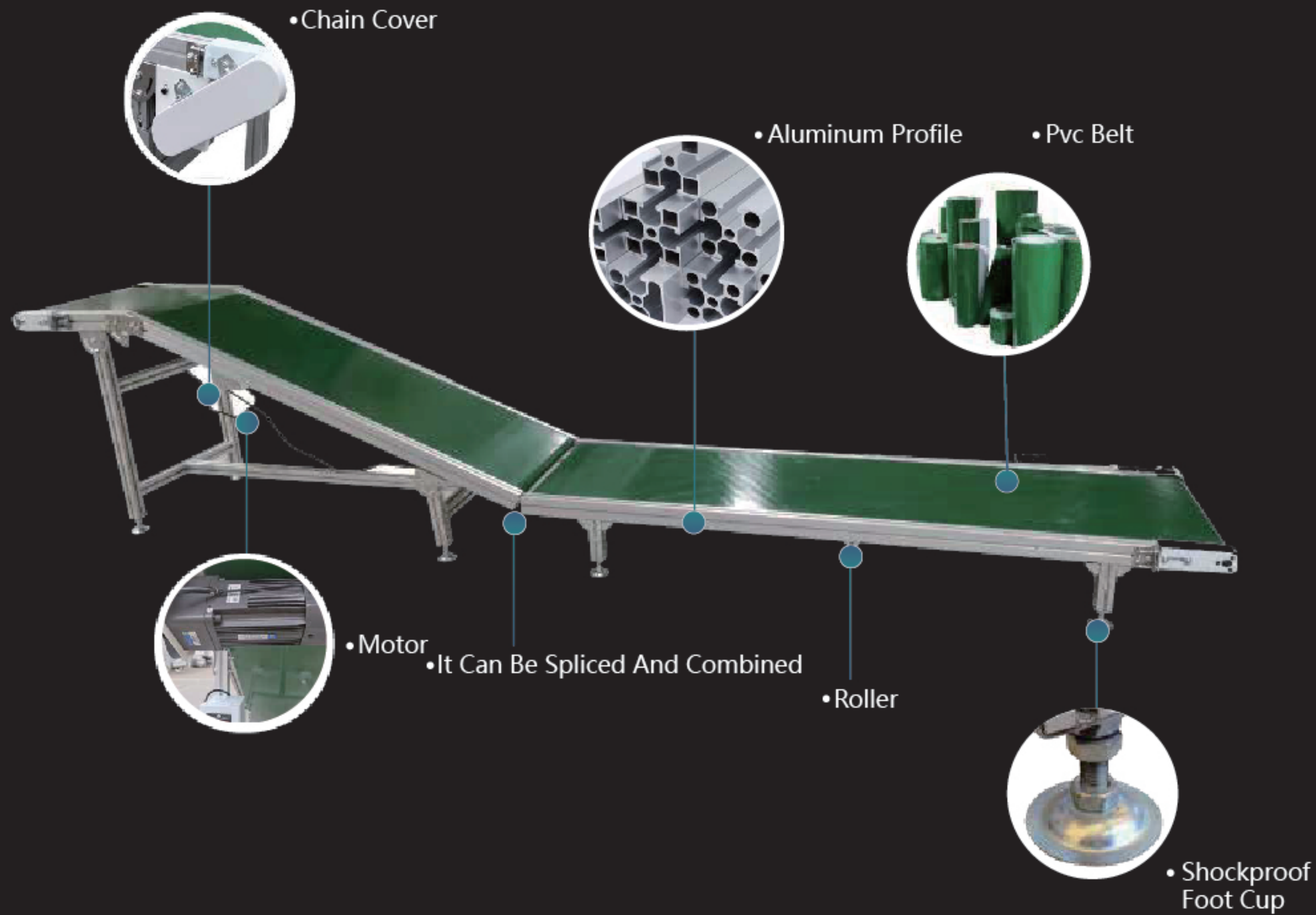

Brand: Yuhai
Name: Inclined Belt Conveyor Assembly
Model Number: Yuhai#006
Product Size: 直线: 2000mm长*300mm宽200mm高
Slope Line: 1500mm长*400mm宽*200mm-700mm高



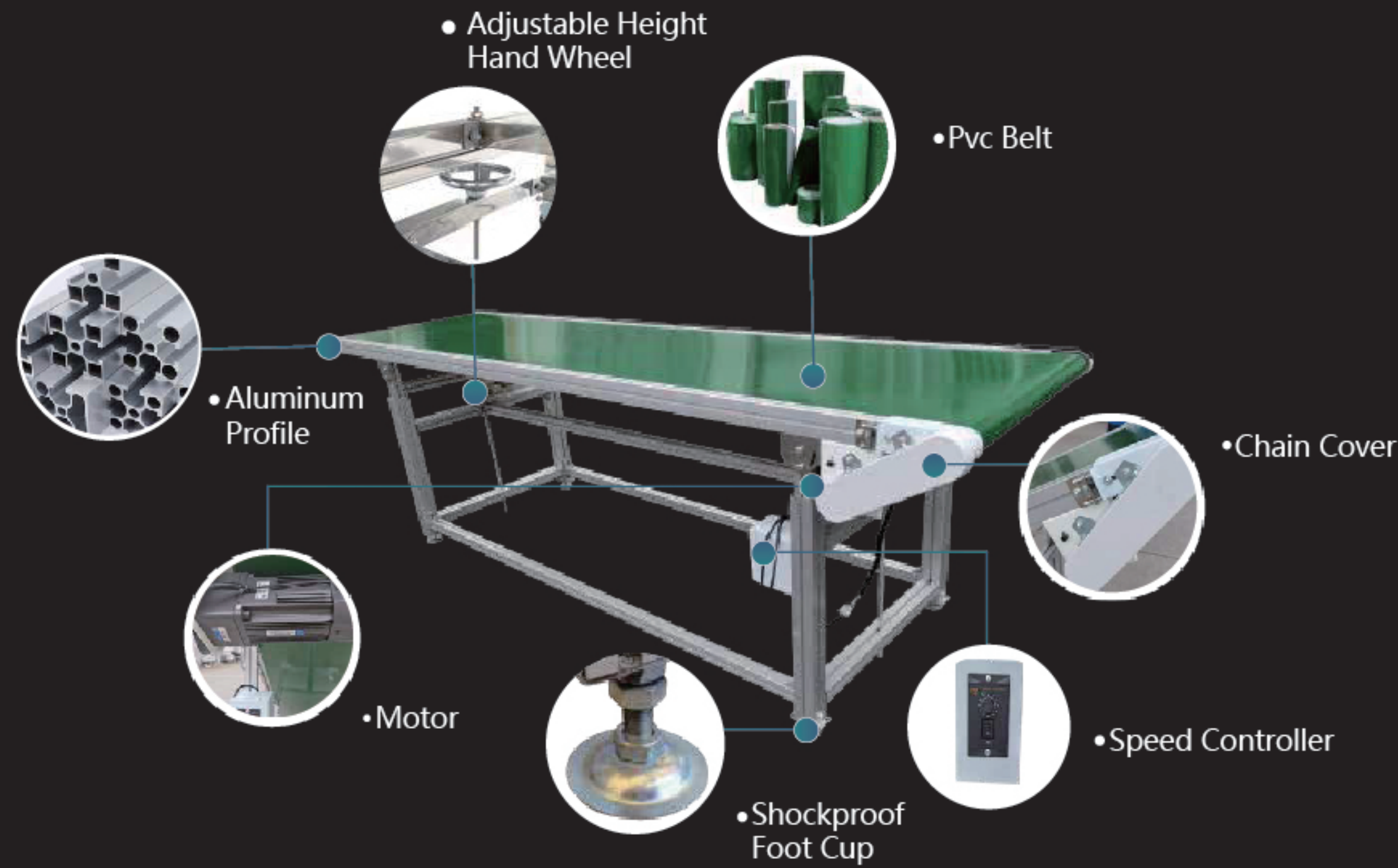

Incline Climbing Machine



Flat Conveyor



Climbing Conveyor



Climbing Conveyor



Z-type Climbing Conveyor



L Mini Climbing Conveyor



Flat Conveyor



Stainless Steel Mesh Belt Conveyor



Heavy Roller Conveyor



Heavy Duty Furniture Belt Conveyor



Flat Steel Plate Conveyor



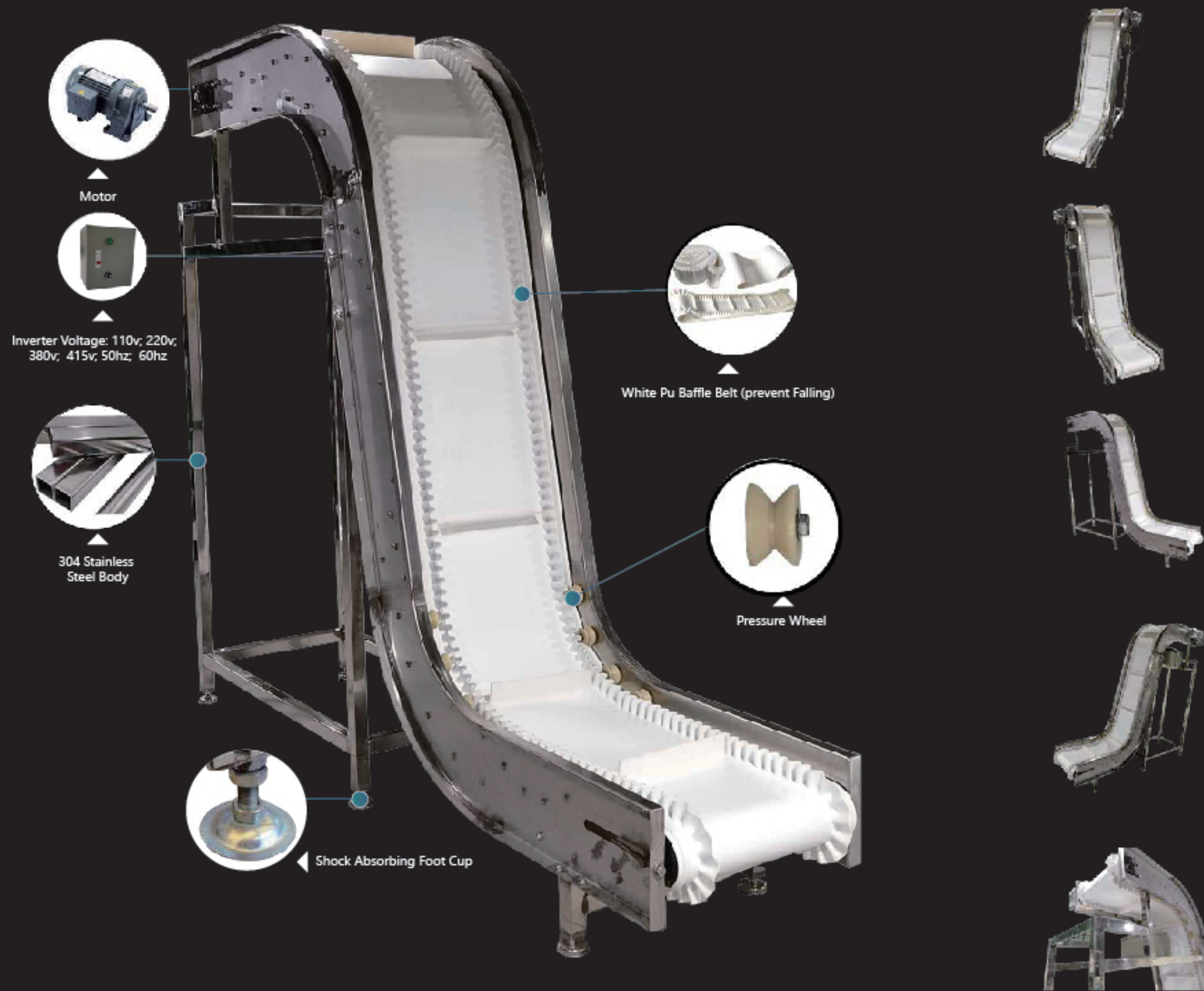

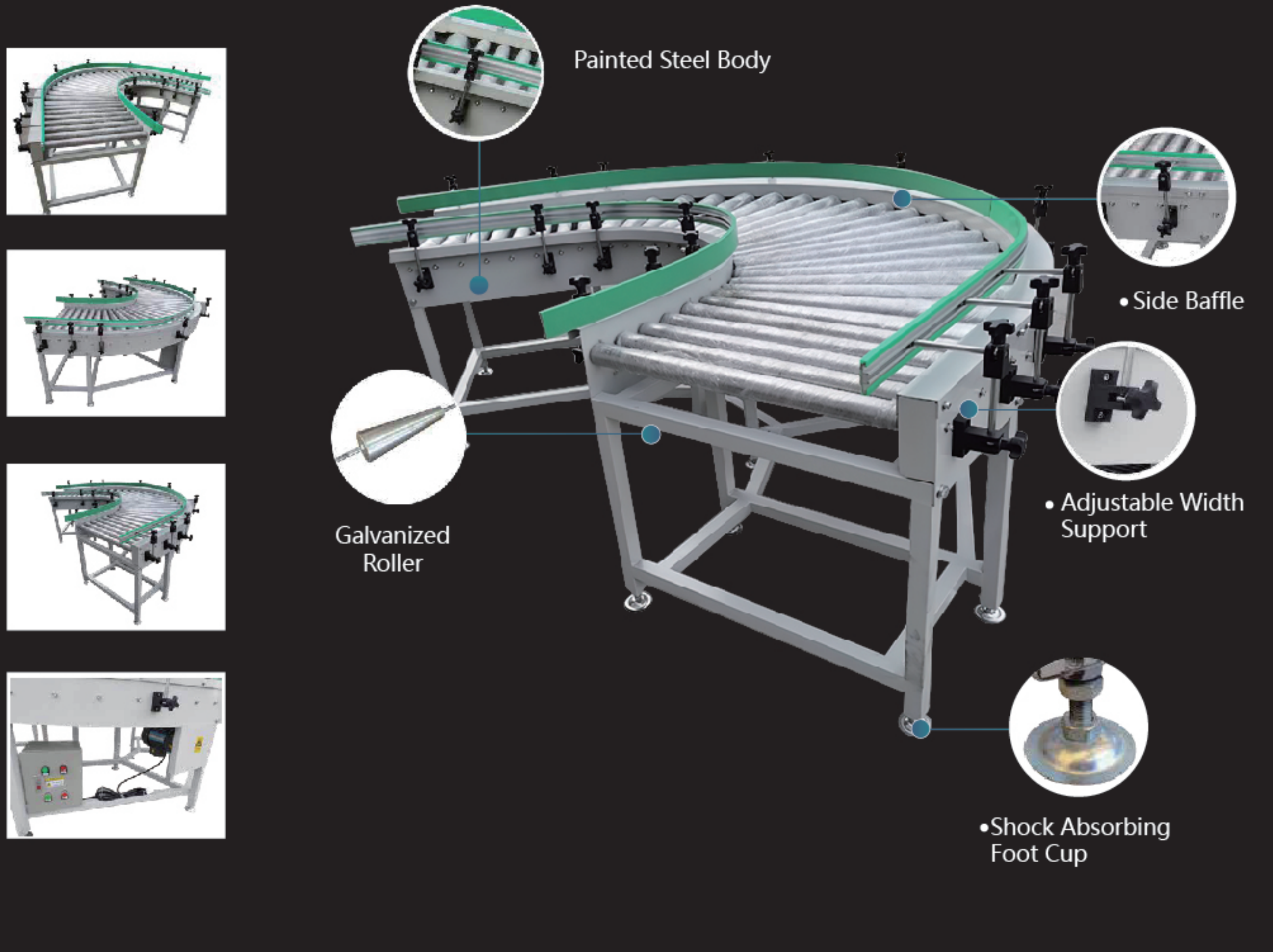

Brand: Yuhai	Motor: 750w
Name: Roller Turning Conveyor	Load-bearing: 200kgs
Model Number: Yuhai#010	Inverter Voltage: 110v; 220v; 380v; 60hz
Product Size: 3500mm长* 500mm宽* 750mm高	Purpose: Conveying Goods
Body Material: Steel Paint Color Customization	Minimum Order Quantity: 1 Set
Drum: Galvanized, 50mm Diameter	Drum Spacing: 100mm
Adjustable Speed: 1-25m/min(1-20/min Slow; 10-15m/min Normal Speed; 15-25m/min Fast)	

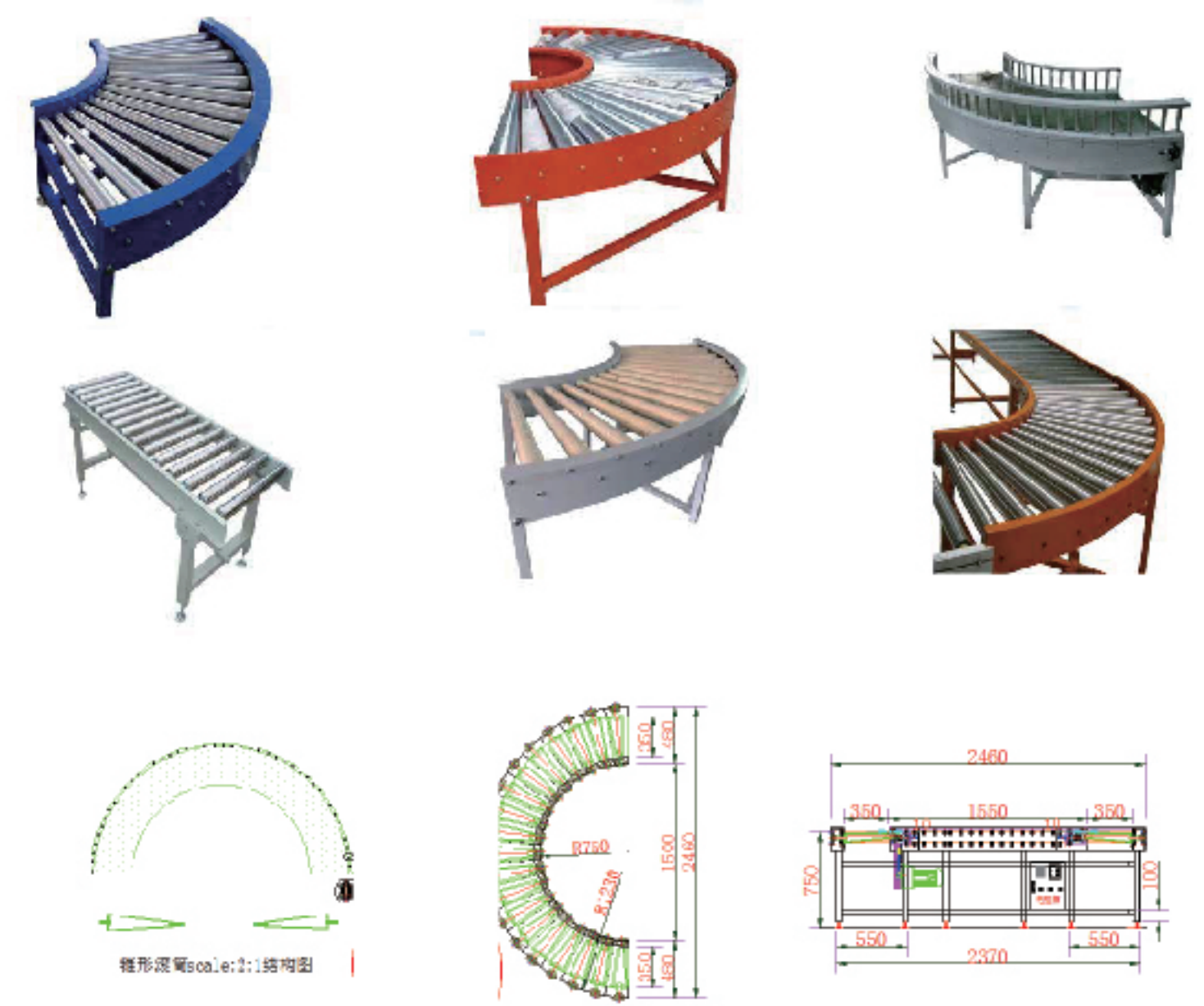

Food Grade Inclined Conveyor



Shunt Inclined Conveyor



Climbing Conveyor



Flapper Belt Conveyor



Small Inclined Conveyor

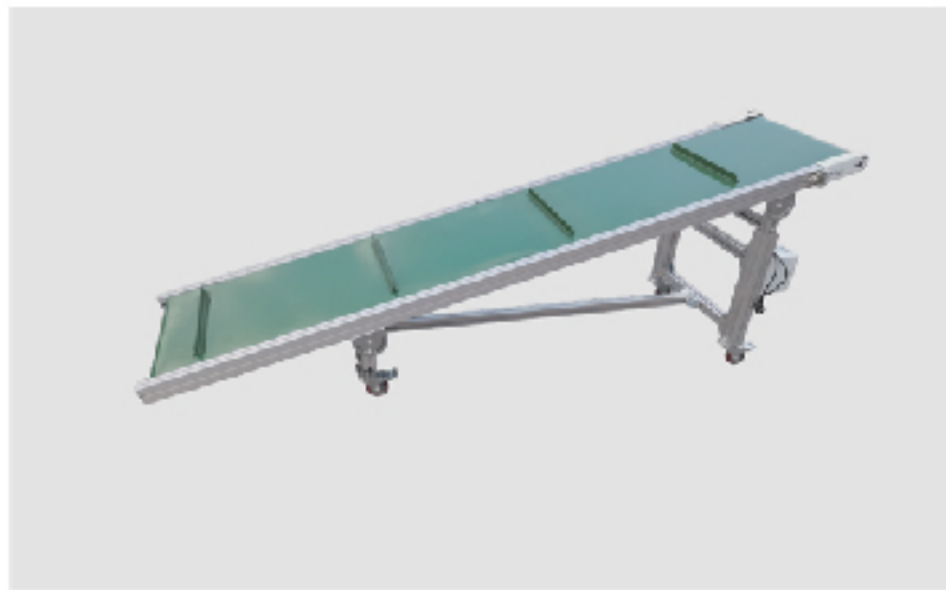

L-type Conveyor



L-type Conveyor



Inclined Conveyor



Hopper Conveyor



Climbing Conveyor



Small Climbing Conveyor

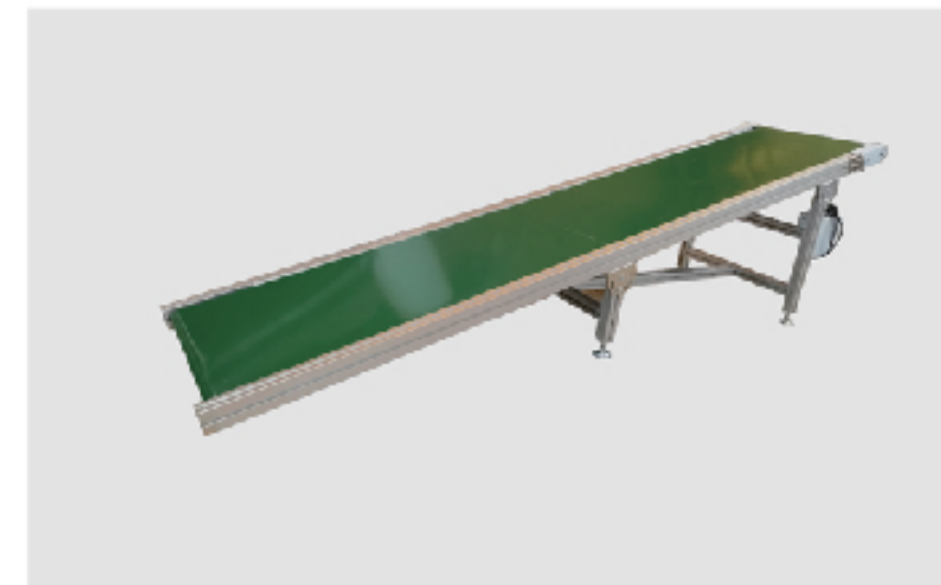

Flapper Belt Conveyor







Brand: Yuhai	Name: Hopper Inclined Conveyor Line
Model Number: Yuhai#009	Product Size: 3000mm长*250mm宽*2000mm高度
Hopper Size: 500*600*700MM	Body Material: Food Grade Stainless Steel
Belt: Green Pvc With Baffle	Purpose: Conveying Goods
Motor: Brand Optional, 60w; 90w; 120w; 200w; 250w; 400w; 750w; 1000w; 1500w	
Inverter Voltage: 110v; 220v; 380v; 415v; 50hz; 60hz	
Adjustable Speed: 1-25m/min(1-20/min Slow; 10-15m/min Normal Speed; 15-25m/min Fast)	
Maximum Load: 50kgs	Minimum Order Quantity: 1 Set
Delivery Time: 5 Days Volume Negotiable	Installation: Provide Installation Video; Online Guidance; Onsite Installation.



Stainless Steel Power Drum Line



Unpowered Roller Conveyor



Power Roller Conveyor



Power Roller Conveyor



Cylinder Roller Conveyor



Small Power Roller Conveyor

360-degree Rotatable Unpowered Loading And Unloading Conveyor

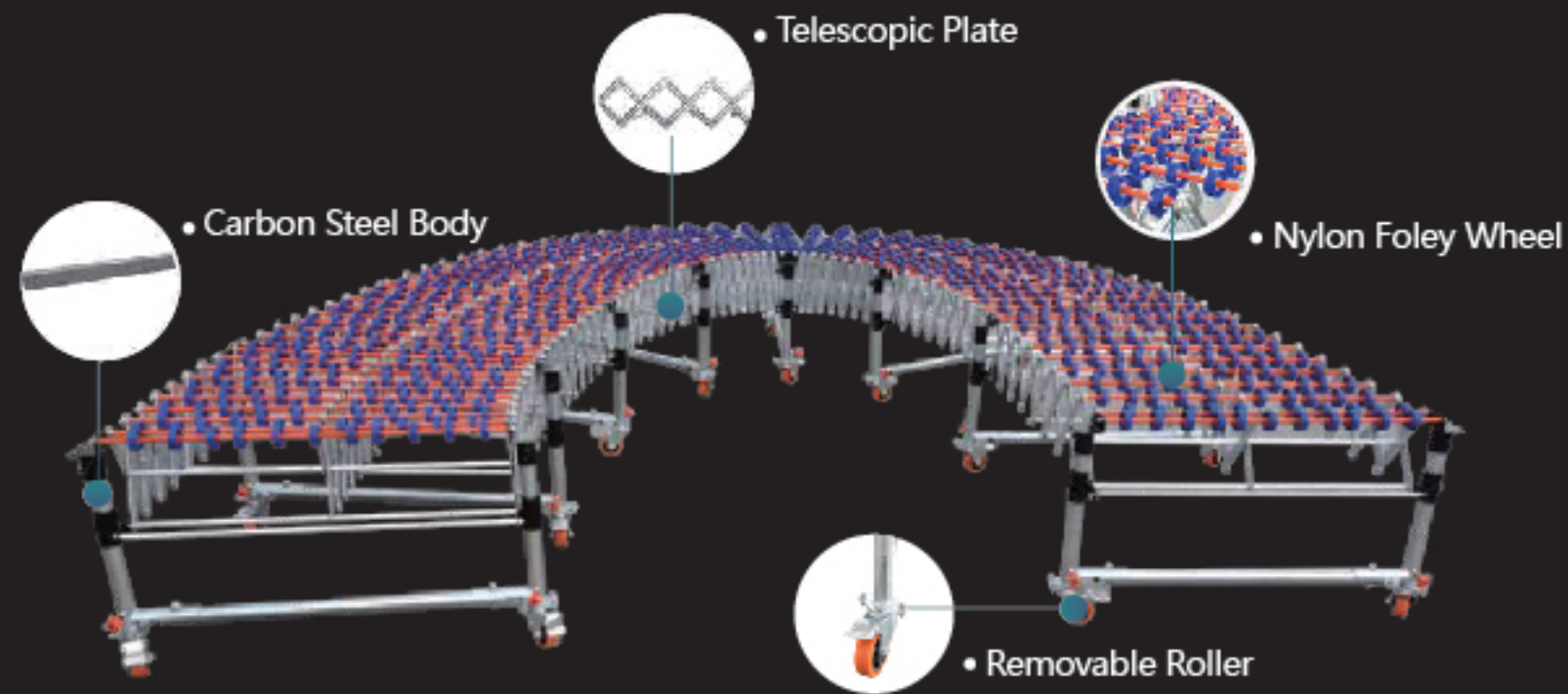

Roller Telescopic Machine

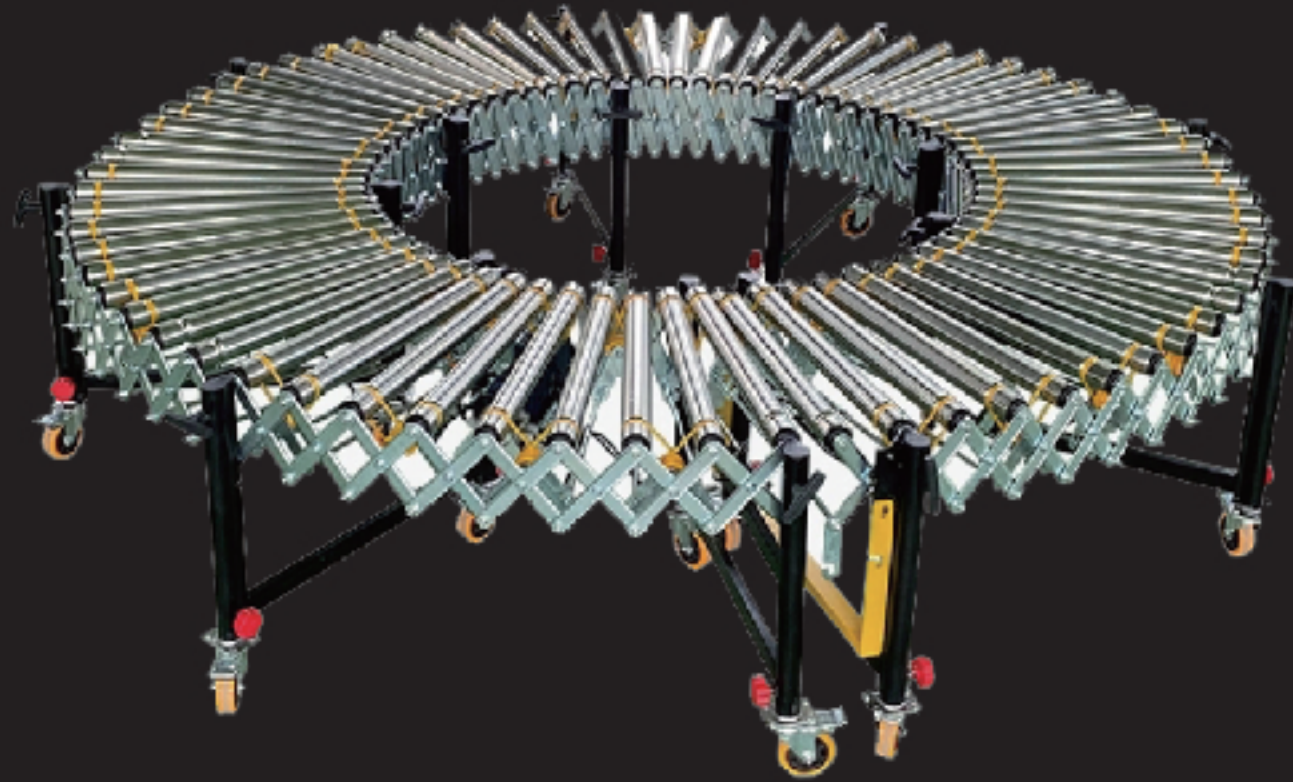

Heavy Cargo Handling Conveyor

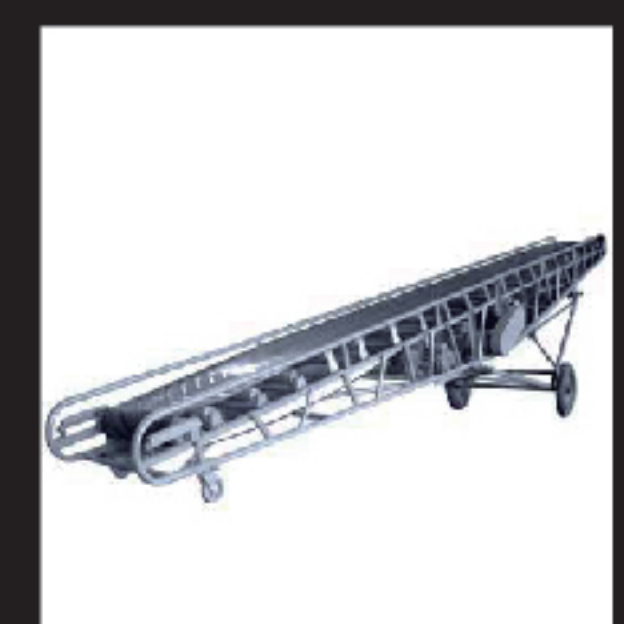
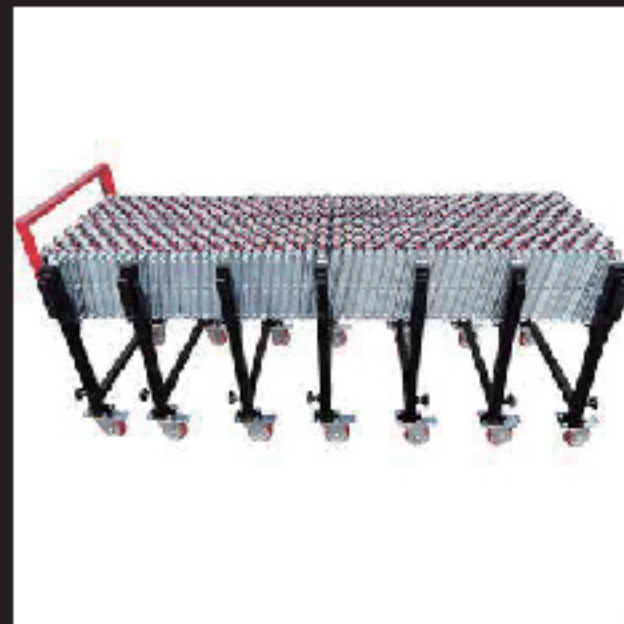
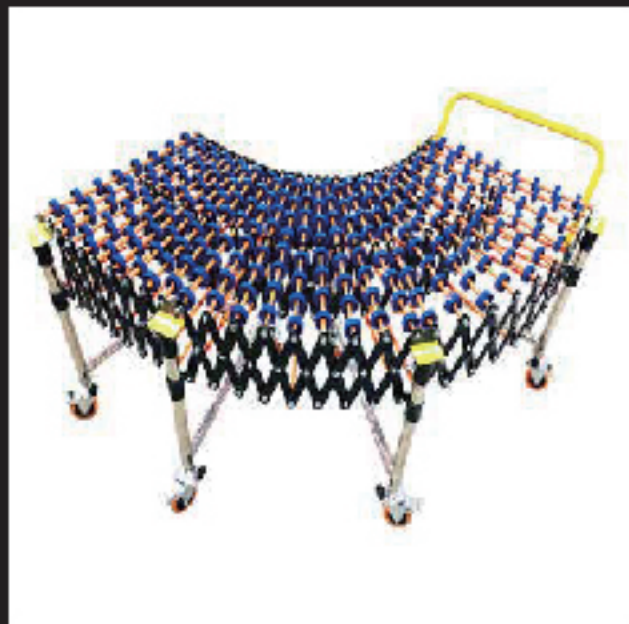

Teflon Mesh Belt Conveyor



Food Grade High Temperature Teflon Conveyor, With High Temperature Anti-virus Oven Tunnel Furnace System



Food Conveyor With Cooling Fan



Food Grade Pu Belt Conveyor

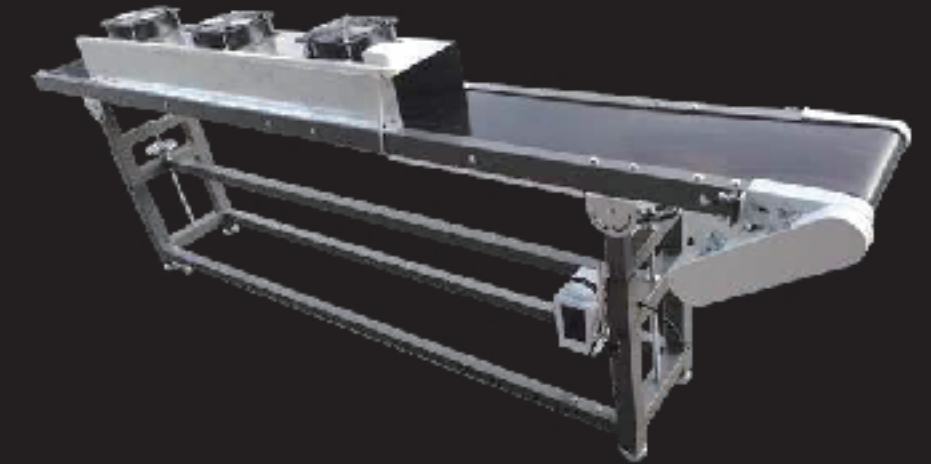

Food Grade Teflon Belt Conveyor, Belt Resistance To High Temperature 200 Degrees



High Temperature Resistance 200 Degrees Teflon Mesh Belt Conveyor, With Cooling Fan System



High Temperature Food Grade Silicone Conveyor



White Chain Plate Conveyor



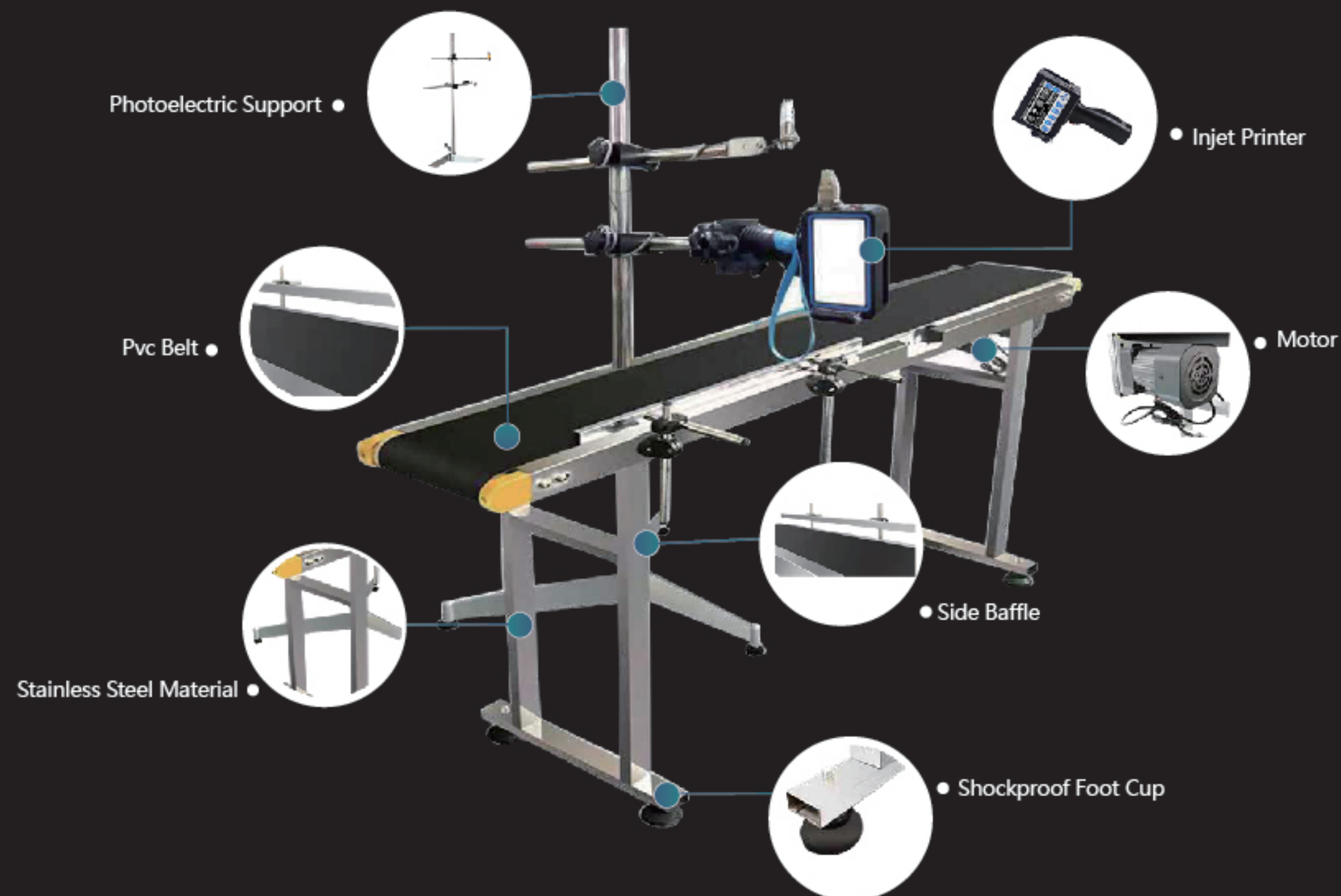

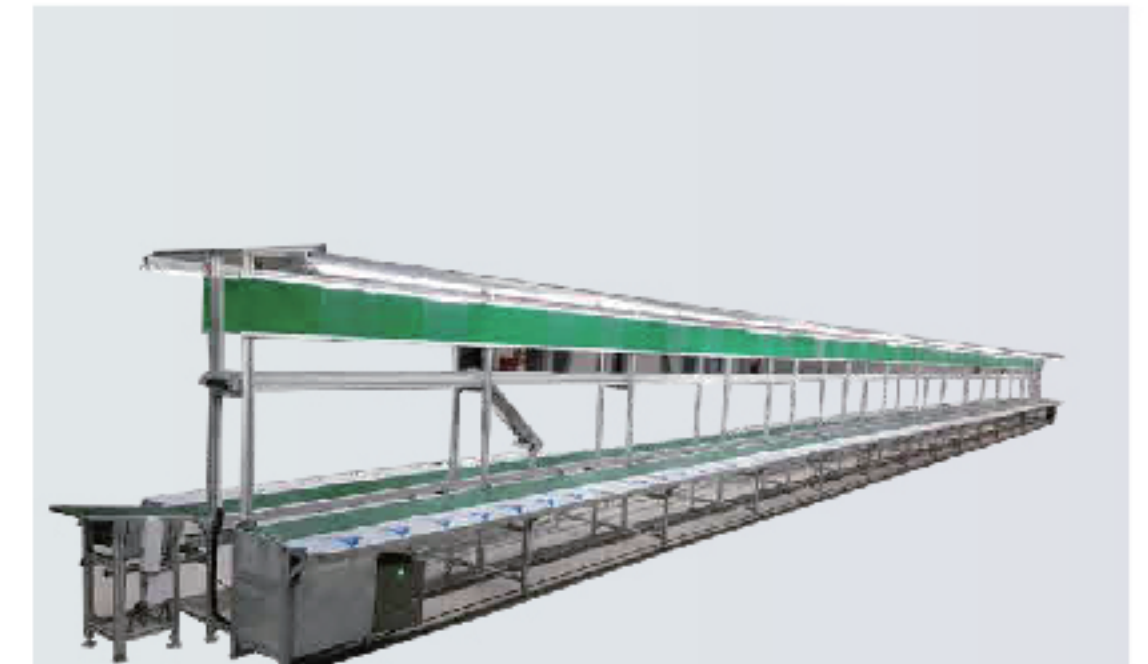
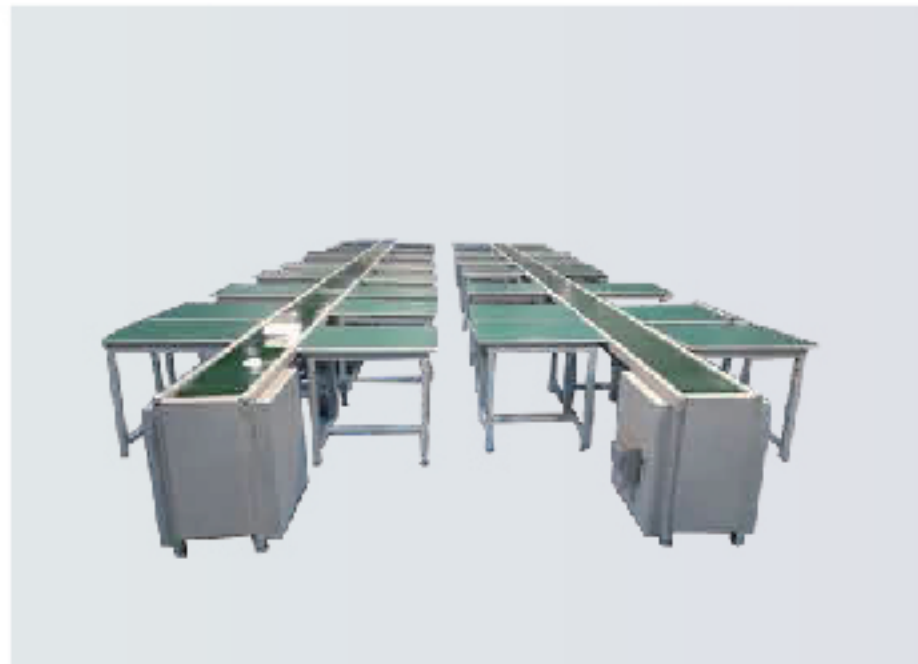

Conveyer Work Table



Stainless Steel Conveyor With High Temperature Resistance



Small Conveyor

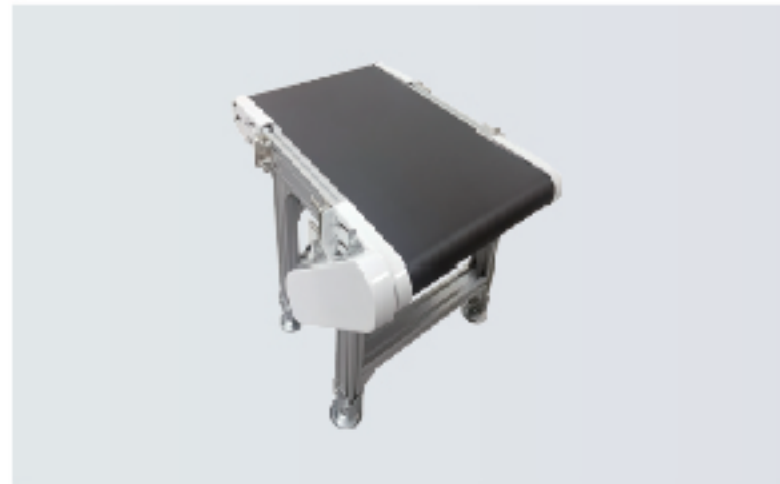

Small Table Conveyor



Chain Plate Conveyor



Double-deck Mini Conveyor

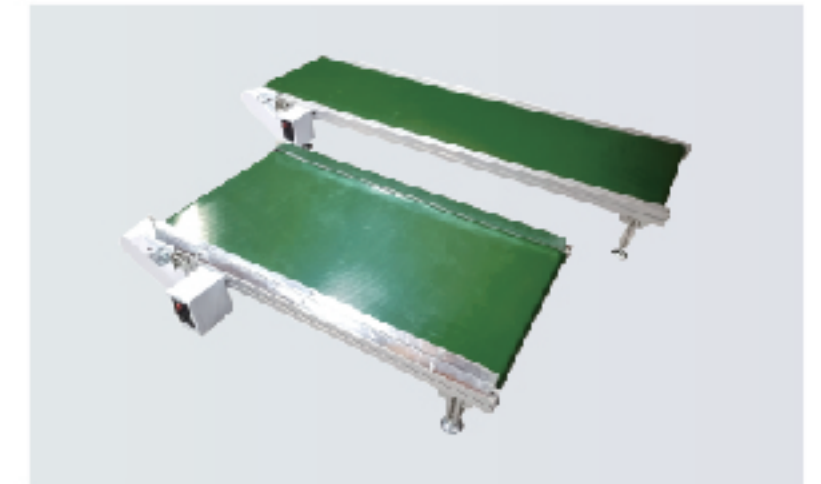

Side Baffle Conveyor



Adjustable Baffle Conveyor



Tell Running Dirt Conveyor

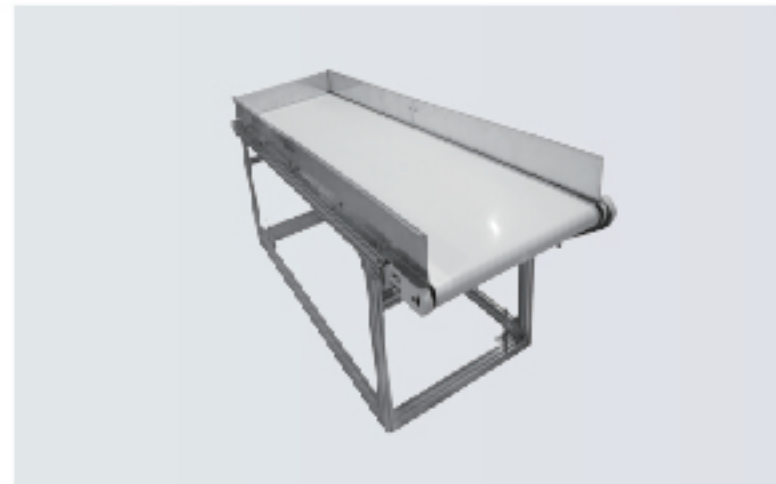

Chain Plate Conveyor



Heavy Duty Handling Conveyor



Double Layer Extrusion Conveyor

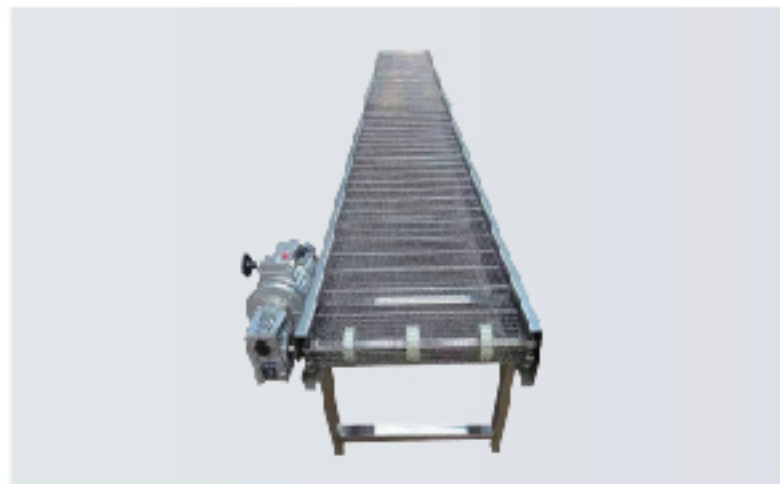

Double-deck Conveyor



Food Grade Conveyor

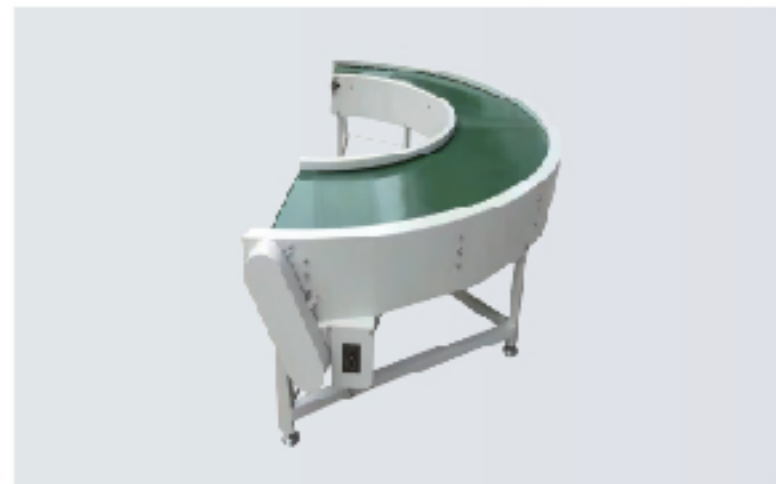

Food Conveyor



High Speed Conveyor

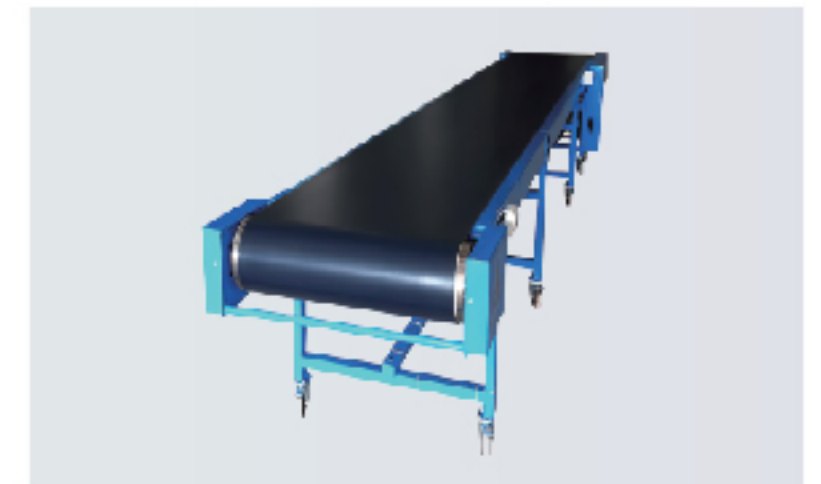

Stainless Steel Conveyor



Adjustable Height Conveyor



Belt Conveyor For Pickoff

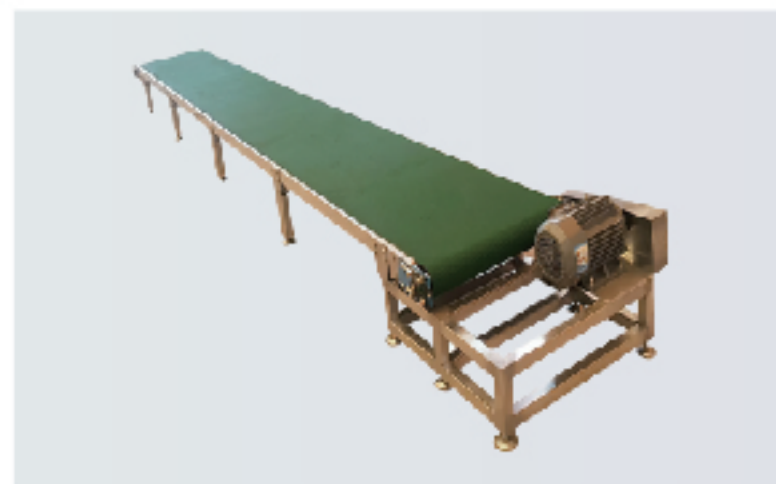

Small Ramp Conveyor



Black Belt Conveyor



Turning Machine

Non-standard Customization, Any Angle Can Be Customized, Paint Steel Body, Super Bearing, Adjustable Speed, Stable Transmission, Suitable For Warehouse Logistics Sorting Line, Workshop Production Line, Etc

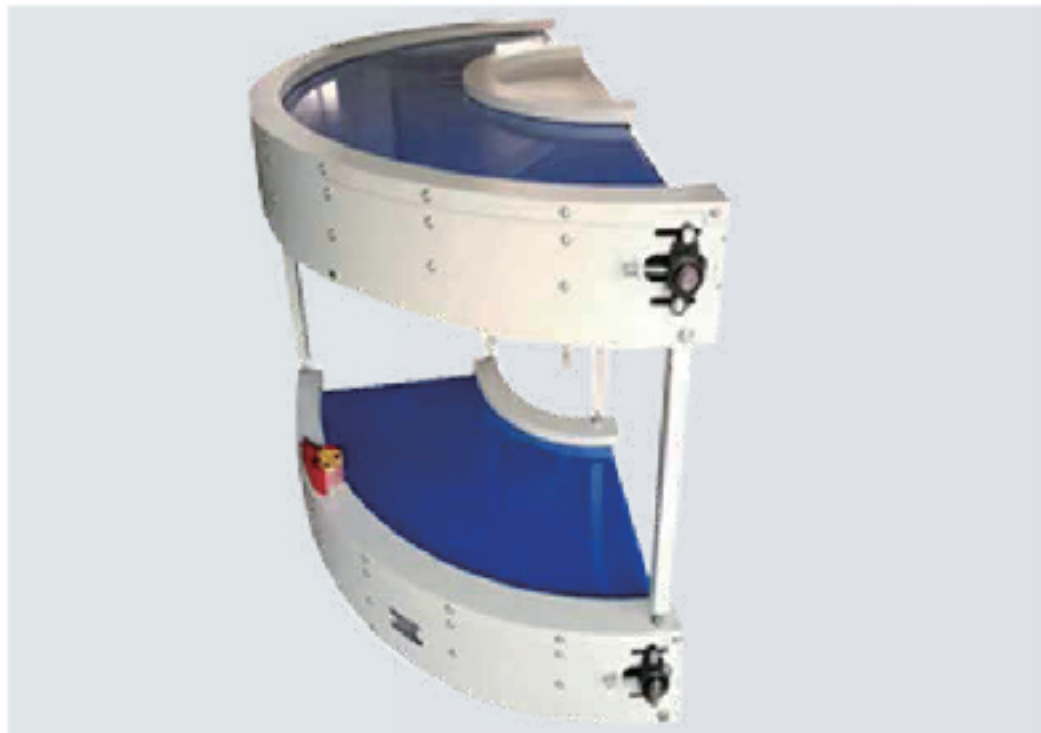

Double-deck Turning Machine

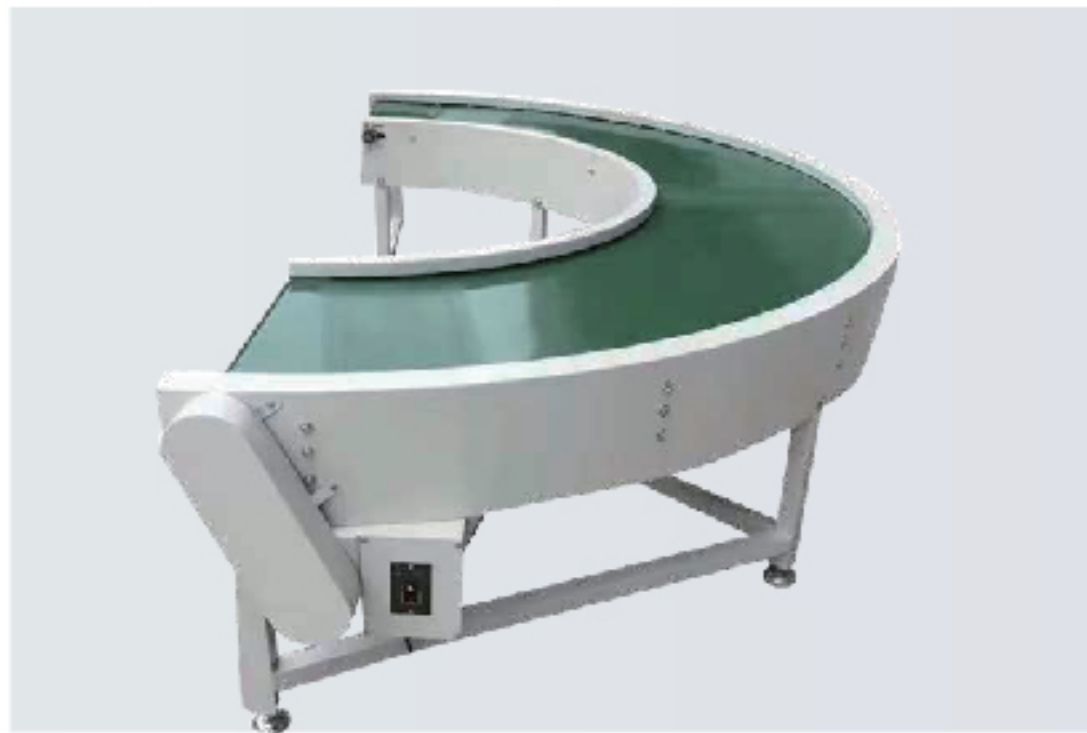

Arbitrary Angle Turning Machine



Circulating Conveyor System



90 Degree Conveyor

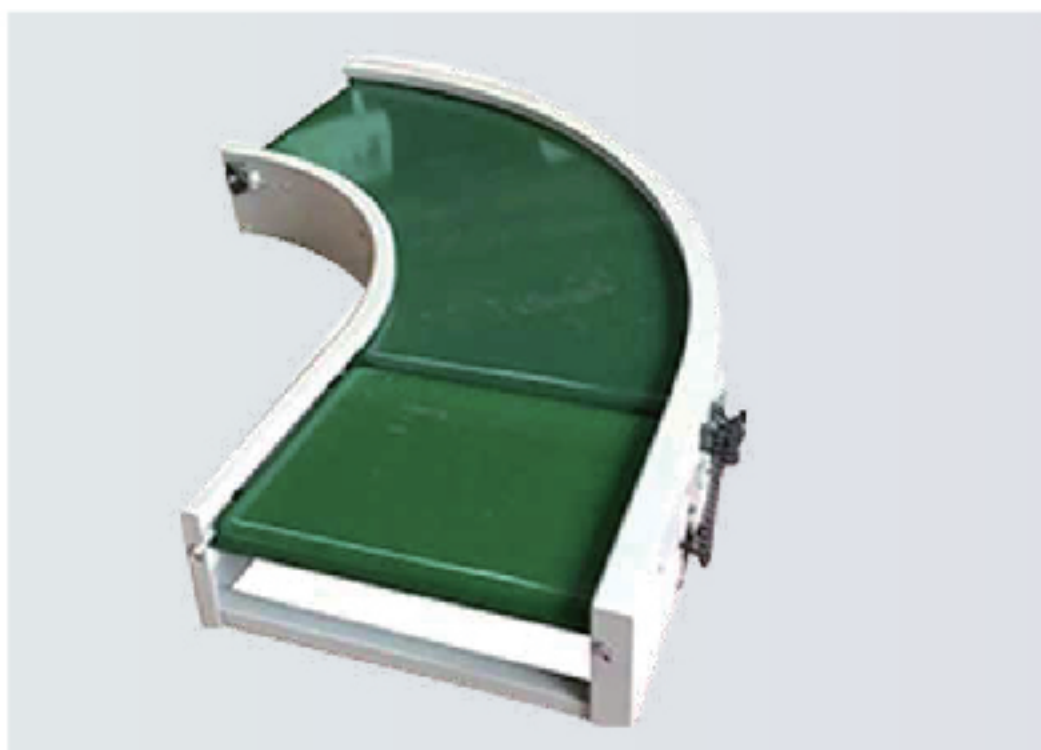

Custom Turning Machine



180 Degree Turning Machine



180 Degree Turning Machine



360-degree Turning Machine

Customer Service

About Design And Ordering:

The company's products are widely used, most of them are non-standard customized conveyor, we have our own professional sales, technology, design, production, team, according to your production site and process needs for your design, proofing, etc., to cooperate with you to buy the most suitable, the most preferential unique customized machine! Please feel free to contact our professional sales staff to consult and order! Welcome to visit our company at any time!

About Production:

Common styles and sizes, 3-7 days after the order can be shipped, other styles 7-10 days, we have professional sales personnel one to one follow-up service, provide production pictures and videos so that customers can know the progress of the order at any time, customers confirm the complete machine and debugging video can be packaged and shipped!

About Installation:

Common models, we provide installation video and online technical guidance, other complex models or large conveyor systems, provide door-to-door installation services!

About After-Sales Service:

In order to allow customers to use our products for a long time with peace of mind, we provide high-quality after-sales maintenance system, in case of operation problems or machine failure, our engineers will provide timely video guidance or on-site service! Welcome customers to put forward valuable comments and more other suggestions, we will feed back to the R & D department for product improvement and upgrade and new product research and development!